

”Weatherproof“ for outdoor installation





KF 0202 G

- 0.75-2.5 mm², Cu 3~

IP
66/67

IP
69







- terminal with 2 clamping units per pole
- 5-pole per pole 8 x 0,75 mm² f, 6 x 1,5 mm² r / f, 4 x 2,5 mm² r / f, 2 x 4 mm² r / f
- cable entries via knockouts, order AKM separately (see cable entry systems LES)
- "weatherproof" resistant to weather influences (UV due to solar radiation, protected against rainwater, temperature resistant, impact resistant, etc.)
- saltwater-proof
- "offshore applications"
- lid fasteners sealable without accessories
- retaining strap and external brackets for wall fixing included
- colour: grey, RAL 7035

rated insulation voltage	U _i = 690 V a.c./d.c.
rated current:	20 A
material	PC-GFS (polycarbonate)
degree of protection	IP 66 / IP 67 / IP 69 IP 67, temporary submersion IP 69, water pressure max. 100 bar, water temperature max. 80 °C, distance ≥ 0.15 m
width	93 mm
height	93 mm
depth	62 mm
weight	0,141 kg
tightening torque for terminal	0.5 Nm
in accordance with	IEC 60670-22
in accordance with	DNV GL - Certificate No: TAE00000EE

Drawings

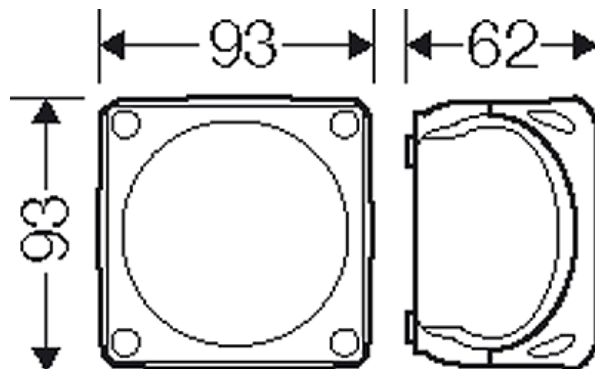
Dimension drawing



”Weatherproof“ for outdoor installation





KF 0202 G

- 0.75-2.5 mm², Cu 3~

IP
66/67

IP
69



Detail mass



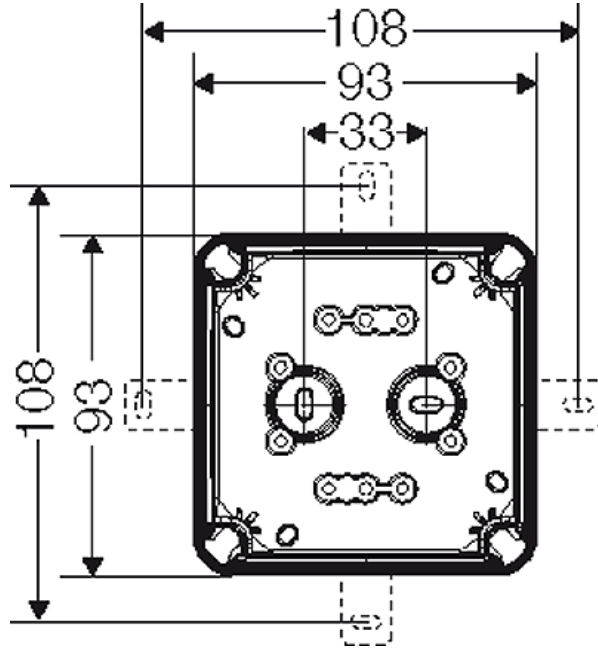

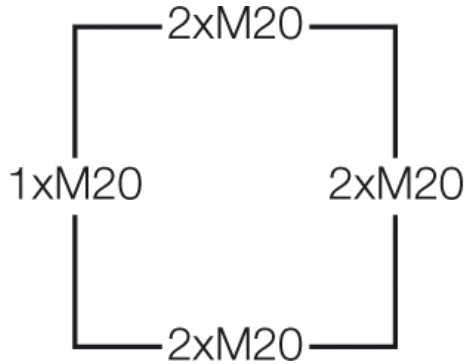

Box walls



Operating and ambient conditions

Application area	Suitable for outdoor installation (harsh environment and/or outdoor). To reduce the formation and accumulation of condensed water see technical information.
Resistant to occasional cleaning procedures (direct jet)	Resistance to occasional cleaning procedures (direct jet) with high-pressure cleaner without cleaning additives, water pressure: max 100 bar, water temperature: max 80 °C, distance ≥ 0.15 m, in accordance with DIN EN 60529:2014-09 (IEC 60529:2013) = IP 69. Only with cable entries HENSEL AKM or ASS.
Ambient temperature	Average value over 24 hours + 55 °C Maximum value + 70 °C Minimum value - 25 °C
Relative humidity	50% at 40° C short-time 100% at 25° C
Fire protection in the event of internal faults	Demands placed on electrical devices from standards and laws Minimum requirements

”Weatherproof“ for outdoor installation

	<p>KF 0202 G</p>			
	<ul style="list-style-type: none"> • 0.75-2.5 mm², Cu 3~ 			
				

	<ul style="list-style-type: none"> - Glow wire test in accordance with IEC 60695-2-11: - 650°C for boxes and cable glands - 850°C for parts of insulating material necessary to retain current carrying parts in position
<p>Burning behaviour</p>	<p>Glow wire test IEC 60695-2-11: 960 °C UL Subject 94: V-0 flame-retardant self-extinguishing</p>
<p>Degree of protection against mechanical load</p>	<p>IK09 (10 Joule)</p>
<p>Toxic behaviour</p>	<p>halogen-free silicone-free "halogen-free" in accordance with the examination of the cables and insulated wires - corrosiveness of fumes - as per IEC 60754-2</p>
<p>Note:</p>	<p>For material properties see technical data.</p>